





Mud

Directed by Asia Gagnon

Carnegie Mellon University

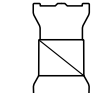
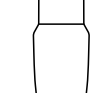
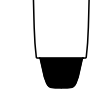
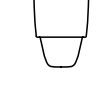
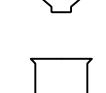
Assistant Director Patrick Zakem	Stage Manager Christina Benvegna
Production Manager Jess Bertollo	Assistant Production Manager Shannon Henley
Scenic Designer Joey Sarno	Costume Designer Madeline Mikkelsen
Lighting Designer Evan Shimizu	Master Electrician Andrew Schmedake

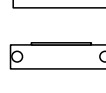

Instrument Key

-  Source 4 26°
-  Source 4 36°
-  Source 4 50° @ 750W
-  Source 4 LED 36°
-  S4 PAR WFL
-  S4 PAR MFL
-  6" Fresnel
-  L&E Mini Strip

Accessories

-  Floor Plate
-  Coloram II 7.5" Scroller
-  7.5" 4 Leaf Barn Door
-  Template Holder

Key

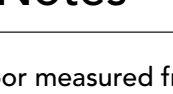
-  Color
-  Light Number
-  Channel

Notes

All trusses are 20' off the floor measured from bottom of truss.

Revisions

Date	Reason
3/23/13	Revision #6
3/18/13	Revision #5
3/18/13	Revision #4
3/18/13	Plot Review
3/14/13	Revision #3
3/13/13	Revision #2
3/13/13	Revision #1

THIS DRAWING REPRESENTS VISUAL CONCEPTS AND CONSTRUCTION SUGGESTIONS ONLY. THE DESIGNER IS NOT QUALIFIED TO DETERMINE THE STRUCTURAL APPROPRIATENESS OF THIS DESIGN AND WILL NOT ASSUME RESPONSIBILITY FOR IMPROPER ENGINEERING.

Light Plot - Truss and Deck

Scale: 1/2" = 1'-0"

Sheet no. **1** of 2

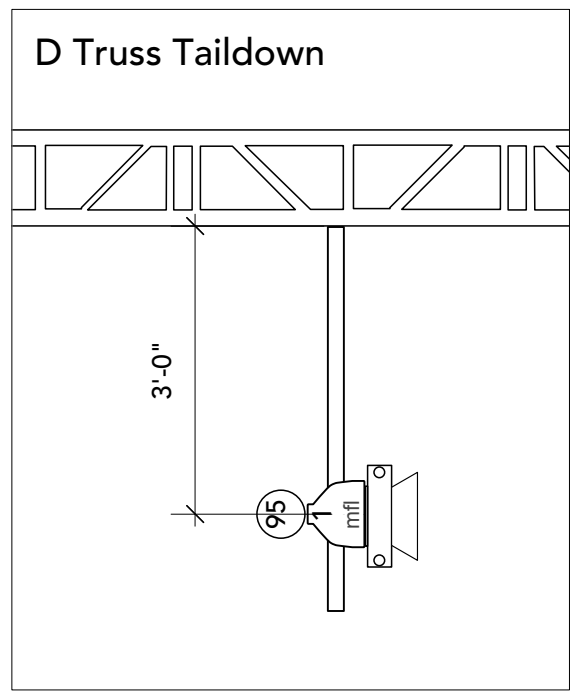
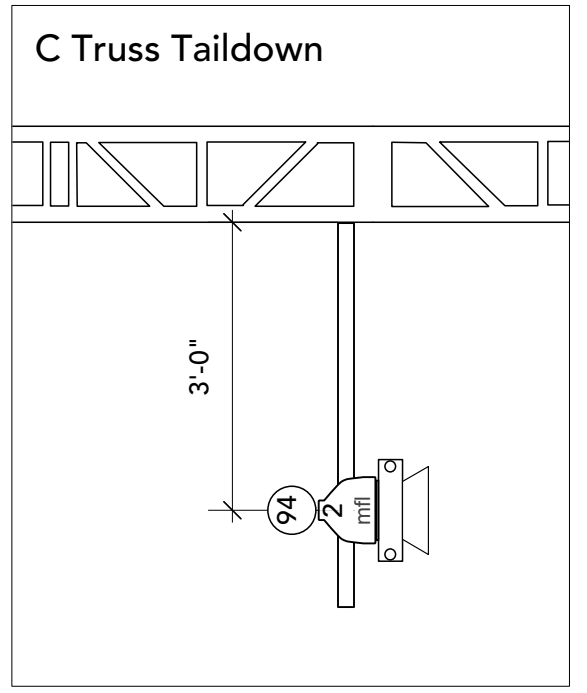
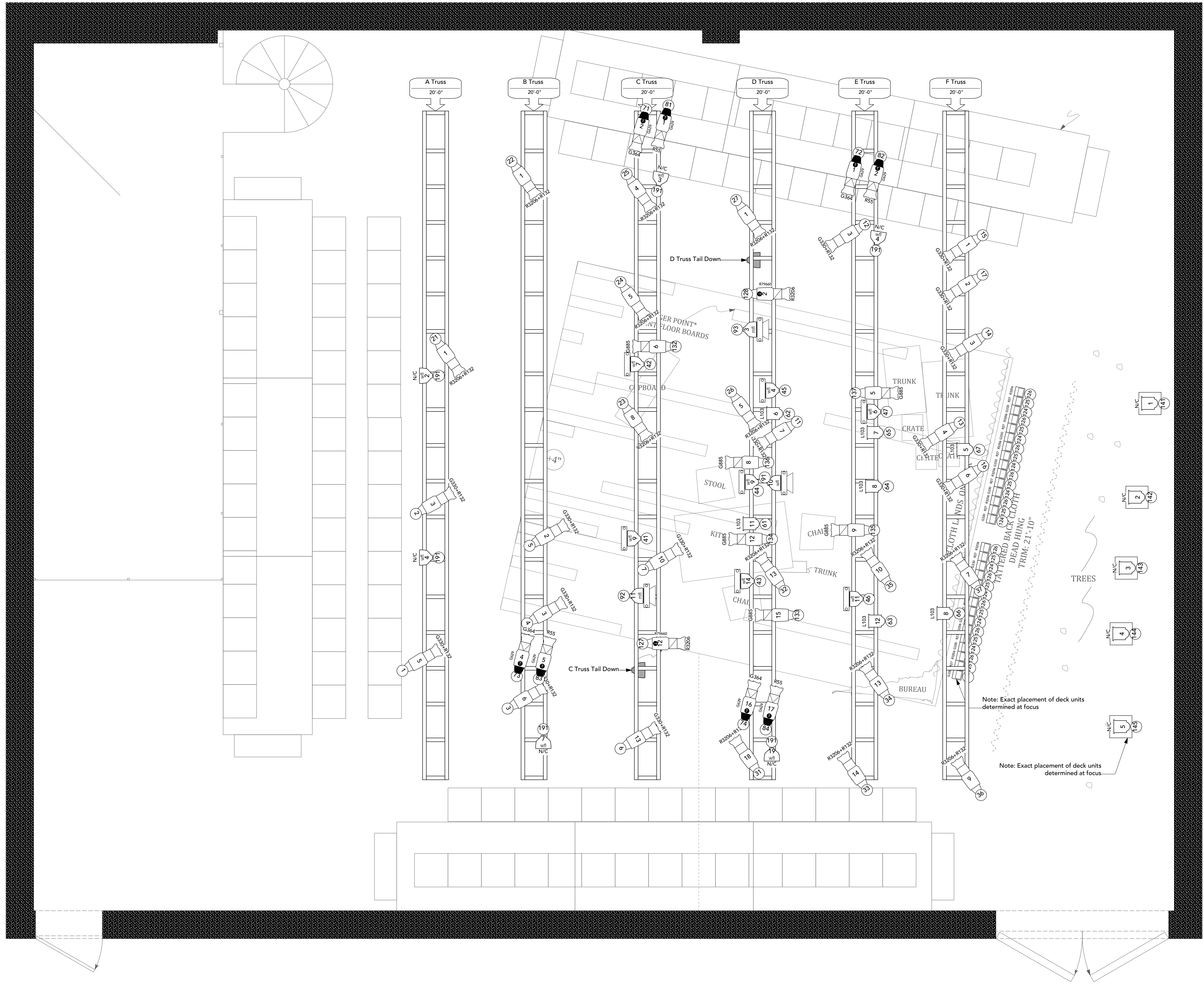









Mud

Directed by Asia Gagnon





Carnegie Mellon University

Assistant Director Patrick Zakem	Stage Manager Christina Benvegna
Production Manager Jess Bertollo	Assistant Production Manager Shannon Henley
Scenic Designer Joey Sarno	Costume Designer Madeline Mikkelson
Lighting Designer Evan Shimizu	Master Electrician Andrew Schmedake



Instrument Key

-  Source 4 26°
-  Source 4 36°
-  Source 4 50° @ 750W
-  Source 4 LED 36°
-  S4 PAR WFL
-  S4 PAR MFL
-  6" Fresnel
-  L&E Mini Strip

Accessories

-  Floor Plate
-  Coloram II 7.5" Scroller
-  7.5" 4 Leaf Barn Door
-  Template Holder

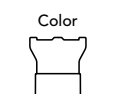
Key

-  Color
-  Light Number
-  Channel

Notes

All trusses are 20' off the floor measured from bottom of truss.

Revisions

Date	Reason
3/23/13	Revision #6
3/18/13	Revision #5
3/18/13	Revision #4
3/18/13	Plot Review
3/14/13	Revision #3
3/13/13	Revision #2
3/13/13	Revision #1

THIS DRAWING REPRESENTS VISUAL CONCEPTS AND CONSTRUCTION SUGGESTIONS ONLY. THE DESIGNER IS NOT QUALIFIED TO DETERMINE THE STRUCTURAL APPROPRIATENESS OF THIS DESIGN AND WILL NOT ASSUME RESPONSIBILITY FOR IMPROPER ENGINEERING.

Light Plot - Grid

Scale: 1/2" = 1'-0"

Sheet no. **2** of 2

